

ICOM

INSTRUCTION MANUAL

UHF REPEATER
IC-RP4020

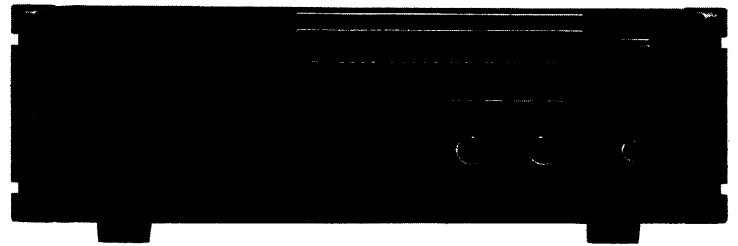

Icom Inc.

INTRODUCTION

Thank you for choosing this new Icom product.

Icom's advanced new **IC-RP4020 UHF REPEATER** is designed to meet the increasing demand of today's amateur radio operators for high precision, sophisticated radio communications.

EXPLICIT DEFINITIONS

The following explicit definitions apply to this instruction manual.

WORD	DEFINITION
WARNING	Personal injury, fire hazard or electric shock may occur.
CAUTION	Equipment damage may occur.
NOTE	If disregarded, inconvenience only. No personal injury, risk of fire or electric shock.

UNPACKING

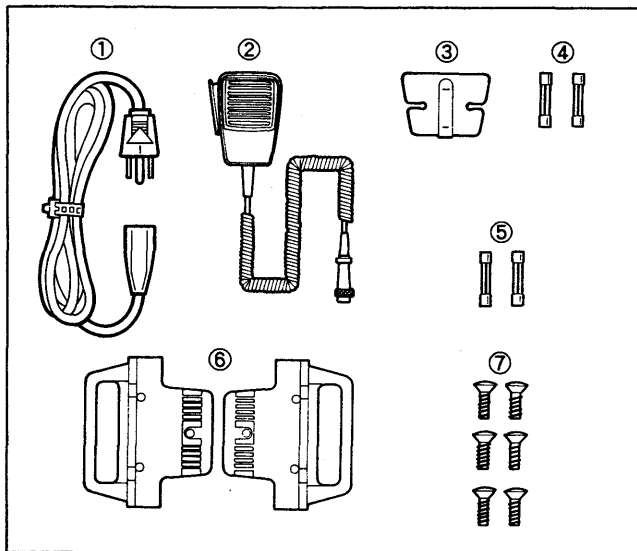

Accessories included with the IC-RP4020:	Qty.
① AC power cable	1
② Microphone (HM-4)	1
③ Microphone hook	1
④ Spare fuses for AC line *1	2
⑤ Spare fuses for DC line *2	2
⑥ Rack mounting handles	2
⑦ Screws for rack mounting handle	6

*1 3 A for 10 W and 25 W versions
5 A for 50 W version

*2 10 A for 10 W and 25 W versions
20 A for 50 W version

IMPORTANT

- READ THIS INSTRUCTION MANUAL CAREFULLY** before attempting operation. If you have any questions regarding the operation of the IC-RP4020, feel free to contact your nearest authorized Icom Dealer or Service Center.
- SAVE THIS INSTRUCTION MANUAL.** This instruction manual contains important safety and operating instructions for the IC-RP4020.

PRECAUTIONS

- UNPLUG** the AC power cable from the AC outlet and wait a few minutes when removing the repeater cover.
- NEVER** let metal, wire or other objects touch any internal part of the repeater. Risk of electric shock could occur.
- NEVER** place the repeater within the reach of babies or children at any time.
- NEVER** expose the repeater to rain, snow or any liquid.
- DO NOT** operate the repeater when it is covered by objects which impede heat dispersal.
- AVOID** using the repeater in temperatures below -10°C ($+14^{\circ}\text{F}$) or over $+60^{\circ}\text{C}$ ($+140^{\circ}\text{F}$). The transceiver may not function properly in extreme temperatures.
- AVOID** using the repeater in excessively dusty environments.
- AVOID** placing the repeater in direct sunlight.
- Keep connection cables as far away as possible from electronic instruments. This will prevent instrument malfunctions.

NOTE: The IC-RP4020 does not come with a duplexer. The duplexer must be purchased separately. For duplexer information, please ask your nearest authorized Icom Dealer or Service Center.

TABLE OF CONTENTS

INTRODUCTION	i	4. BASIC PRESETTINGS	7~9
EXPLICIT DEFINITIONS	i	4-1 SETTING A FREQUENCY	7
UNPACKING	i	4-2 SETTING A TONE FREQUENCY	8
IMPORTANT	i	5. FUNCTIONS PRESETTINGS AND	
PRECAUTIONS	i	OPERATION	10~14
TABLE OF CONTENTS	ii	5-1 ID FUNCTIONS	10
FEATURES	ii	5-2 HANG-UP TIMER FUNCTION	10
1. CONTROL FUNCTIONS	1~2	5-3 TIME-OUT TIMER FUNCTION	10
1-1 FRONT PANEL	1	5-4 ID TIMING CHART	11
1-2 REAR PANEL	2	5-5 WRITING THE ID CALL SIGN	13
2. INSTALLATION	3~5	5-6 EXTERNAL CONTROL FUNCTION	14
2-1 REAR PANEL CONNECTIONS	3	6. MAINTENANCE	15~16
2-2 LOCATION	4	6-1 REPEATER DISASSEMBLY	15
2-3 ANTENNA	4	6-2 FUSE REPLACEMENT	15
2-4 DUPLEXER	4	6-3 BACKUP BATTERY	15
2-5 GROUNDING	4	6-4 CLEANING	15
2-6 POWER	5	6-5 CPU RESETTING	15
2-7 MICROPHONE CONNECTOR	5	6-6 TROUBLESHOOTING	16
2-8 ACC SOCKET	5	7. INSIDE VIEWS	17~19
3. BASIC OPERATION	6	7-1 TOP VIEW	17
3-1 INITIAL SETTINGS	6	7-2 BOTTOM VIEW	18
3-2 OPERATION	6	7-3 LOGIC-A UNIT	19
		8. SPECIFICATIONS	20

FEATURES

HIGHLY EFFICIENT AND STABLE OUTPUT POWER

Icom's expertise in radio technology has produced the IC-RP4020, an FM repeater highly efficient and completely stable with a PA module used in the transmitter output circuit.

2-WAY POWER SUPPLY SYSTEM

The repeater has two-way, AC and DC power source capability. If AC power to the repeater is interrupted, DC power can be automatically connected as a backup power source.

HEAVY DUTY POWER SUPPLY

A heavy duty power supply unit is adopted to follow load fluctuations and secure continuous 24-hour operation.

REMOTE CONTROL SYSTEM

With an external receiver and the built-in DTMF tone decoder, it is possible to control user-programmable functions. To prevent functioning errors, a 4-bit password is available to control them. The following functions can be remotely controlled from the control operator.

- Tone squelch function ON/OFF
- Tone encoder function ON/OFF
- Tone squelch frequency setting
- Tone encoder frequency setting
- Repeater function ON/OFF
- ID function ON/OFF
- ID signal transmission
- ID signal transmission speed
- Time-out timer setting
- Hang-up timer setting
- Repeater stopping time setting
- CPU resetting
- PLL reference frequency adjustment
- Three additional control outputs ON/OFF

1 CONTROL FUNCTIONS

1-1 FRONT PANEL

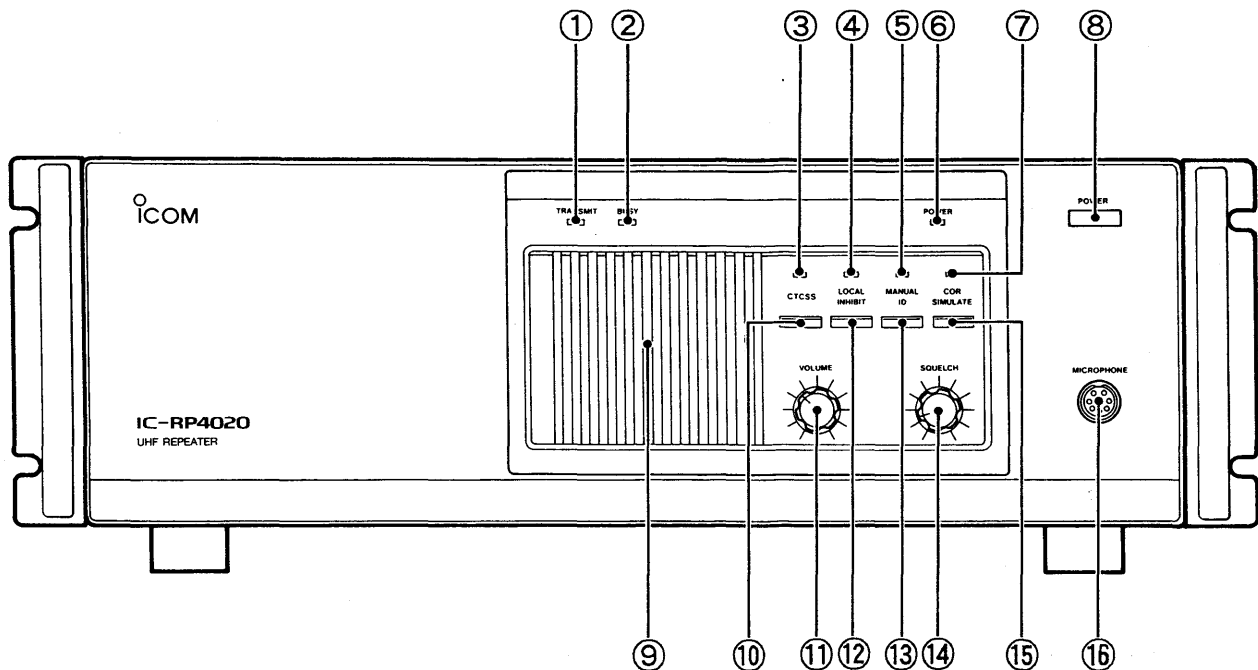

- ① **TRANSMIT INDICATOR [TRANSMIT]**
Lights up when the repeater is transmitting.
- ② **BUSY INDICATOR [BUSY]**
Lights up when the squelch is open.
- ③ **CTCSS INDICATOR [CTCSS]**
Lights up when the tone squelch function is turned ON.
- ④ **LOCAL INHIBIT INDICATOR [LOCAL INHIBIT]**
Lights up when the repeater function is deactivated.
- ⑤ **ID INDICATOR**
Lights up while the ID signal is being transmitted.
- ⑥ **POWER INDICATOR [POWER]**
Lights up when the repeater is in operation.
 - In AC operation: Lights up in green
 - In DC operation: Lights up in red
- ⑦ **COR SIMULATE INDICATOR [COR SIMULATE]**
Lights up when the COR simulate function is turned ON.
- ⑧ **POWER SWITCH [POWER]**
Turns the power ON and OFF.
- ⑨ **SPEAKER**
Monitors the received signal.
- ⑩ **CTCSS (Continuous Tone Controlled Squelch System) SWITCH [CTCSS]**
Turns the tone squelch function ON and OFF.
- ⑪ **VOLUME CONTROL [VOLUME]**
Varies audio output level.
- ⑫ **LOCAL INHIBIT SWITCH [LOCAL INHIBIT]**
Deactivates the repeater function. The repeater functions as a full duplex transceiver.
- ⑬ **MANUAL ID SWITCH [MANUAL ID]**
Transmits an ID (identifier) signal manually. Each push of the switch emits an ID signal.
- ⑭ **SQUELCH CONTROL [SQUELCH]**
 - Varies the retransmitting threshold level.
 - Varies the noise squelch threshold level when the repeater function is turned OFF.
- ⑮ **COR (Carrier Operated Relay) SIMULATE SWITCH [COR SIMULATE]**
Sets the repeater in continuous transmit mode for checking repeater operation. See p. 6.
- ⑯ **MIC CONNECTOR**
Accepts the supplied microphone (HM-4).

1-2 REAR PANEL

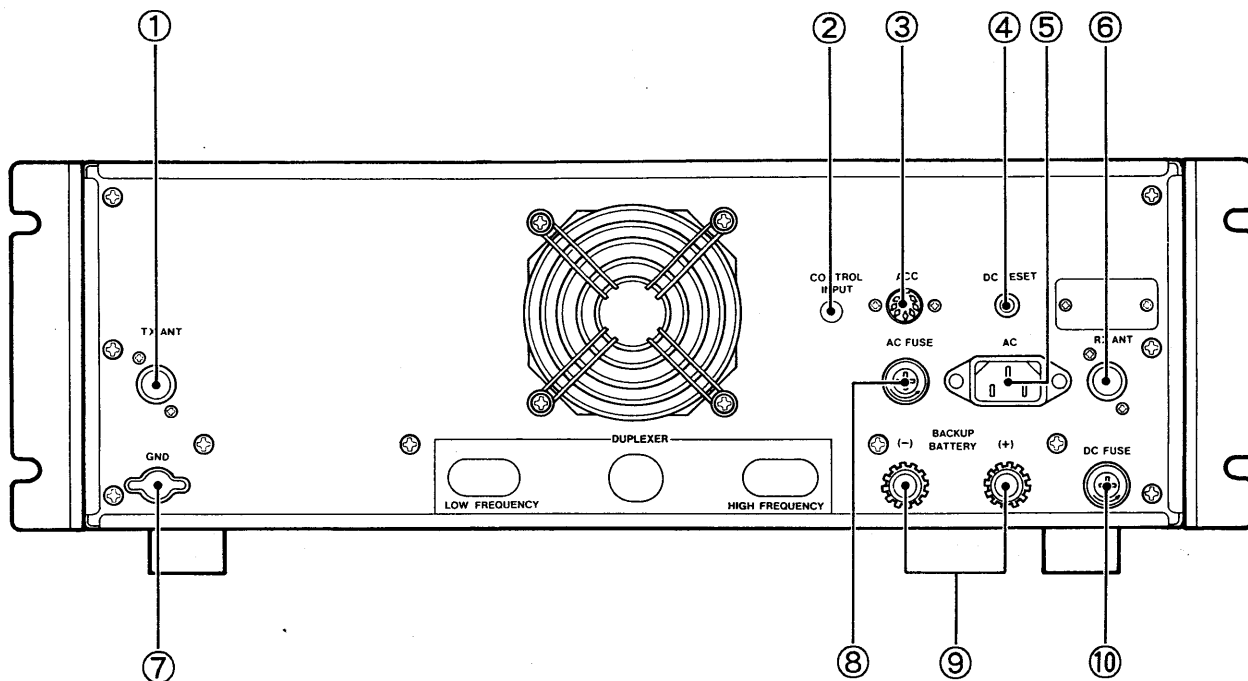
**① TRANSMIT ANTENNA CONNECTOR [TX ANT]**

Outputs the transmitter output power.
Connect to a duplexer with a 50 Ω coaxial cable.

CAUTION: Transmitting without an antenna may damage the transmitter of the repeater.

② CONTROL SIGNAL INPUT JACK [CONTROL INPUT]

Inputs the DTMF remote-control signal.
The repeater is designed for remote control of received DTMF signals when this jack is out of use.

③ ACCESSORY SOCKET [ACC]

Input and output connections for external equipment.

④ DC POWER RESET SWITCH [DC RESET]

Activates the DC power operation.
The switch is also used for canceling the exceeding discharge limiter.

⑤ AC POWER SOCKET [AC]

Connects the supplied AC power cable to a domestic AC outlet.

⑥ RECEIVE ANTENNA CONNECTOR [RX ANT]

Inputs incoming signals from the antenna sent through the duplexer.
Connect to a duplexer with a 50 Ω coaxial cable.

⑦ GROUND TERMINAL [GND]

WARNING: Ground the repeater through this terminal to prevent electrical shocks, TVI, BCI and other problems.

See p. 4 for more information.

⑧ AC FUSE HOLDER [AC FUSE]

Holds the following fuses for the internal AC power supply.

- 10 W and 25 W versions : 3 A
- 50 W version : 5 A

⑨ DC POWER INPUT TERMINALS [BACKUP BATTERY]

Connects a 12 V storage battery for the repeater backup when the AC power is interrupted. These terminals are also used for DC power operation.

⑩ DC FUSE HOLDER [DC FUSE]

Holds the following fuses for the DC power supply.

- 10 W and 25 W versions : 10 A
- 50 W version : 20 A

2 INSTALLATION

2-1 REAR PANEL CONNECTIONS

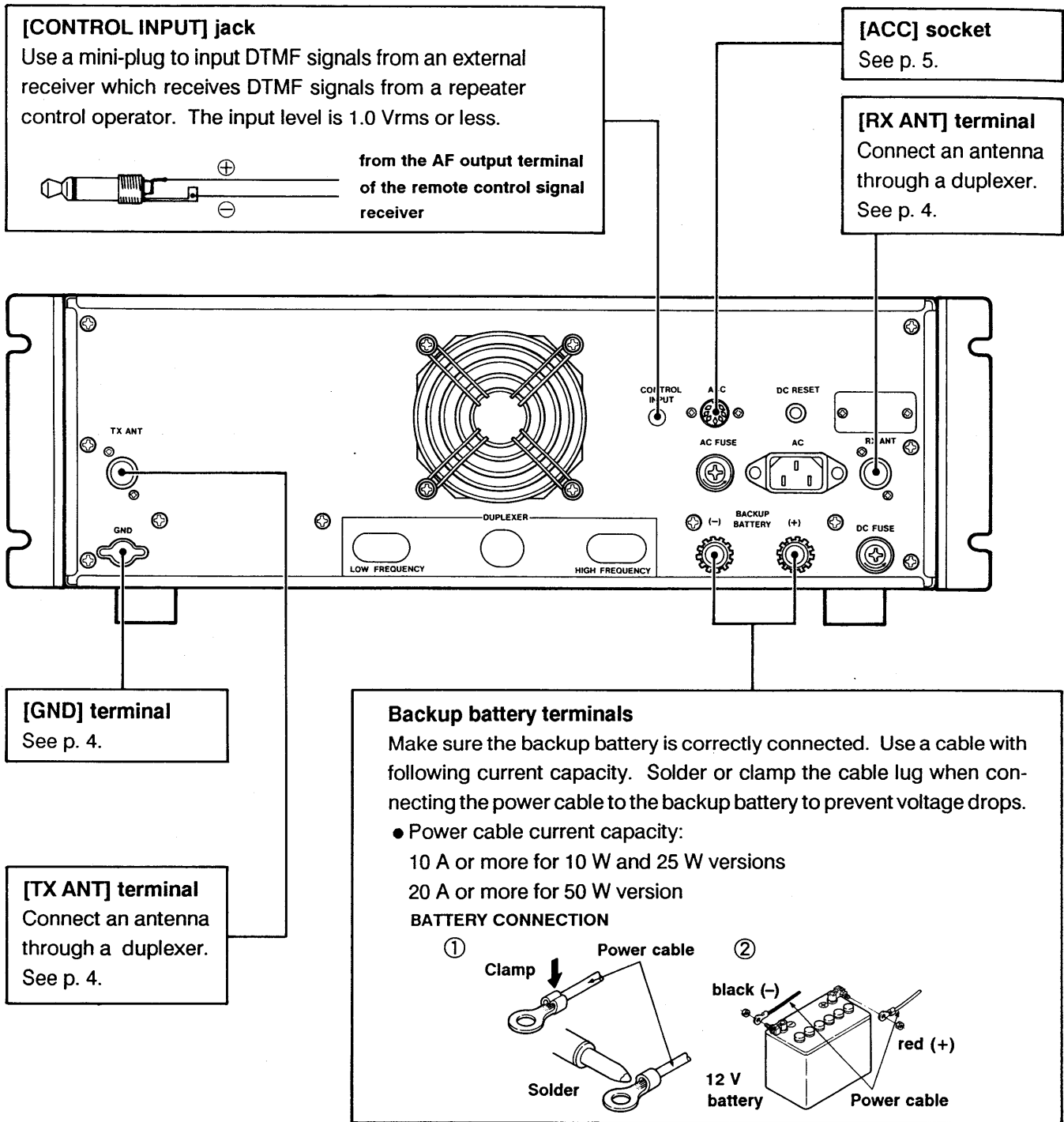

● HANDLE INSTALLATION

- 1) Remove 2 screws from each side of the front panel.
- 2) Attach the supplied handles to the sides of the repeater using the supplied screws as shown in the diagram at right.

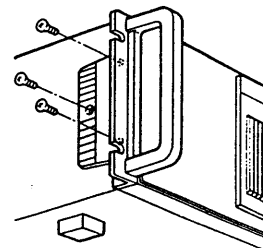

2-2 LOCATION

This repeater should be installed in a cabinet to protect it from dust, moisture, etc. When the supplied mounting handles are attached to each side of the repeater, the repeater may be easily installed to the 19-inch standard cabinet. Read the following installation instructions carefully.

- 1) Select a location to facilitate good ventilation and emergency maintenance, allow sufficient access between the repeater and the surrounding walls.
- 2) AVOID placing the repeater in the environments and conditions described in the PRECAUTION section on inside front cover.

2-3 ANTENNA SYSTEM

CAUTION: Transmitting without an antenna may damage the transmitter of the repeater. Protect your repeater from lightning by using a lightning arrestor.

(1) ANTENNA

Antenna performance is important for reliable radio communications. For this reason, a 50 Ω omnidirectional antenna is well worth the extra investment. A number of high quality fixed location antennas are available from various manufacturers. Choose one most suited to your needs.

Use heavy duty stainless steel mounting hardware to protect the antenna from bad weather and preserve it for longer periods of time.

(2) COAXIAL CABLE

We recommend using a coaxial cable as follows, particularly in a fixed location installation of a repeater where feed lengths are very long.

Use a thick, low loss, all weather-type coaxial cable, and

for best results make the connection between the antenna and repeater as short as possible.

2-4 DUPLEXER

This repeater does not include a duplexer. The duplexer must be purchased separately.

The cables between the repeater and duplexer should be as short and thick as possible to reduce insertion loss.

2-5 GROUNDING

To prevent electrical shocks, TVI, BCI, interference to other stations, and other problems, connect the [GND] terminal on the repeater rear panel to an earth-sunk rod or copper plate with the heaviest gauge wire or strap available and make the connection as short as possible.

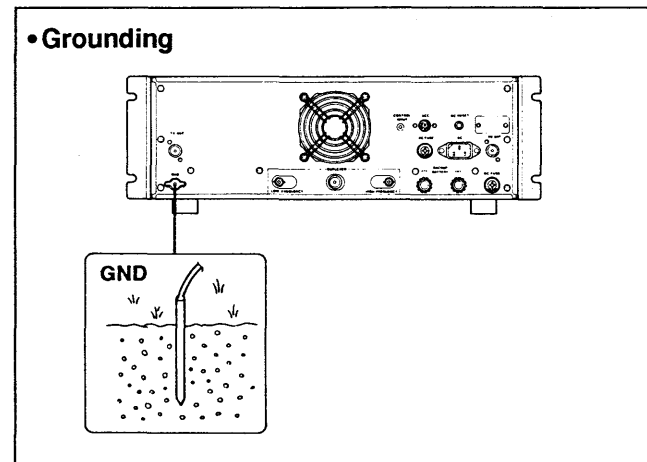

WARNING: NEVER connect the ground terminal to a gas or electrical pipe since the connection could cause an explosion or electric shocks.

TYPE-N CONNECTOR INSTALLATION

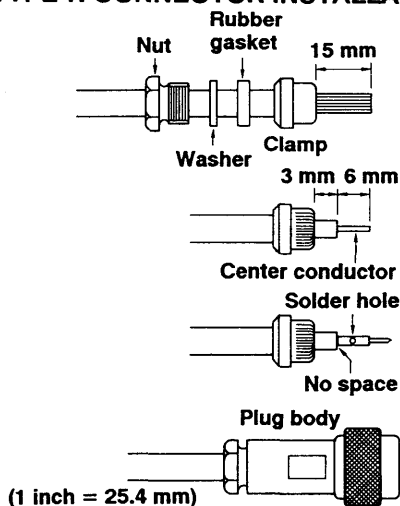

- 1) Slide the nut, washer, rubber gasket and clamp over the coaxial cable. Cut the end of the cable evenly.
- 2) Strip the cables and fold the braid back over the clamp as shown at left.
 - The clamp end should be flush with end of the vinyl jacket.
 - Evenly trim the braid end.
- 3) Soft solder the center conductor. Install the center conductor pin and solder it.
- 4) Carefully slide the plug body into place aligning the center conductor pin on the cable.
 - Tighten the nut onto the plug body.
 - Be sure the center conductor is the same height as the plug body.

2 INSTALLATION

2-6 POWER

Make sure the [POWER] switch is turned OFF when connecting an AC power cable and a backup battery (emergency power supply).

The IC-RP4020 can operate with either an AC or DC power supply. If AC power is interrupted when operating the repeater with an AC power supply, power is automatically provided to the repeater when a 12 V DC battery is connected to the [BACKUP BATTERY] terminals.

(1) IN AC OPERATION

- The [POWER] indicator lights up in green.
- Use the supplied AC power cable for connection to a domestic AC outlet.
- Extension cords should not be used unless absolutely necessary. Using improper extension cords could result in fire risk.
- Usually the battery is continuously charged with a small amount of current from an AC power supply through the regulator circuit in the repeater. Discharging is therefore prevented even if the battery is not used for a long time.

(2) IN DC OPERATION

CAUTION: Voltages greater than 16 V DC will damage the repeater. Check the source voltage before connecting the power cable.

- The [POWER] indicator lights up in red.
- **DO NOT** place the backup battery on or near the repeater. Lead-acid batteries should be placed at least 5 m (16.4 ft.) from the repeater. Use a heavy duty cable to make the connection and be sure both the positive (red) and negative (black) terminals are correctly connected.
- After the battery is connected and the [POWER] switch is ON, the repeater continuously supplies approx. 100 mA for charging the battery. If the repeater stops functioning while connected to the battery, disconnect the battery, recharge it, then push the [DC RESET] switch to continue operations after the battery is charged. During repeater transmissions, approx. 7, 10, and 17 A of battery power is consumed for each 10, 25, and 50 W of repeater output respectively.

2-7 MICROPHONE CONNECTOR

Connect the supplied HM-4 microphone.

For operations with an optional handset, a modification of the repeater is necessary. Remove the repeater top cover, then cut the wire W8 on the LED UNIT.

● Microphone connector (Front panel view)

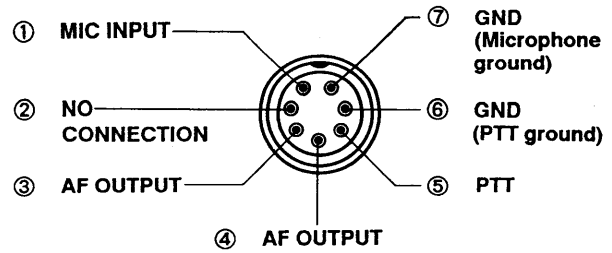

● LED UNIT (Front panel view)

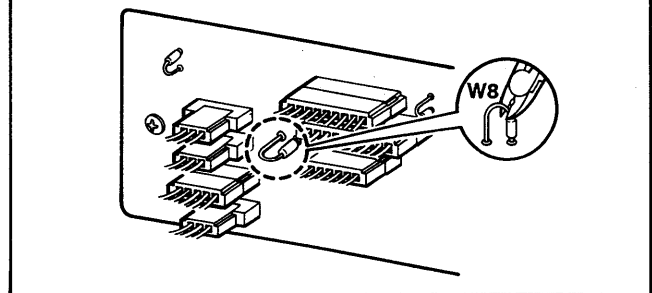

2-8 ACC SOCKET

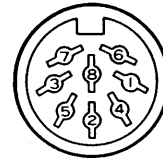

(Rear panel view)

CAUTION: DO NOT short pin 7 to ground as this can damage the internal regulator or DC line fuse.

PIN NO.	PIN NAME	DESCRIPTION	SPECIFICATIONS
1	NC	No connection.	
2	GND	Connects to ground.	
3	SEND	Input/Output pin. When grounded, transmits.	Grounded level : - 0.5 ~ +0.8 V Input current : Less than 20 mA
4	MOD	External modulator input.	Input imp. : 10 kΩ Input level : Approx. 500 mVrms
5	AF	Fixed AF output regardless of [VOLUME].	Output imp.: 1.5 kΩ Output level : Max. 85 mVrms
6	SMLS	Squelch output. Goes to ground when squelch opens.	Squelch open : Less than 0.3 V/5 mA Squelch closed : More than 6.0 V/100 μA
7	13.8 V	13.8 V output.	Output current : Max. 1 A
8	NC	No connection.	

3-1 INITIAL SETTINGS

When applying power for the first time after the purchase of the repeater, be sure to confirm the following points:

- 1) That the [COR SIMULATE] switch is OFF.
- 2) That the [VOLUME] control is rotated maximum counterclockwise.

- 3) Rotate the [SQUELCH] control maximum counterclockwise and confirm that the [BUSY] indicator lights up in green.
- 4) Rotate the [VOLUME] control clockwise and adjust it as desired as the noise comes from the speaker.

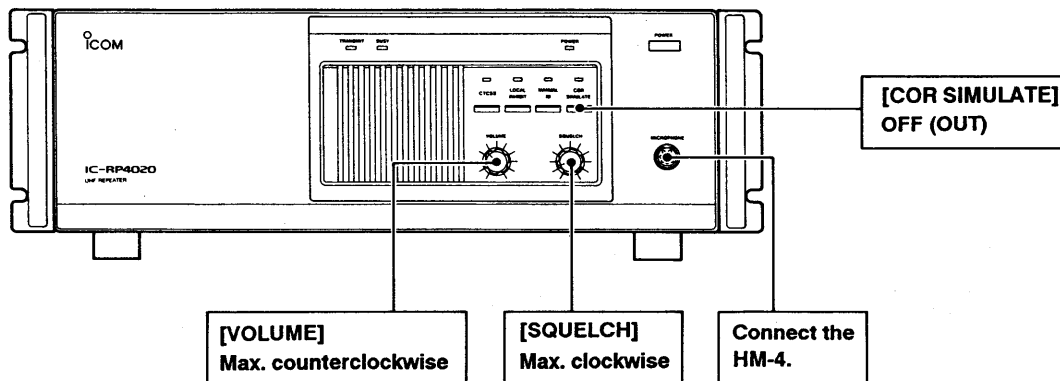

3-2 OPERATION

- 1) Turn the [POWER] switch ON. The [POWER] indicator lights up in green.
 - If the [POWER] indicator lights up in red, AC power is not applied to the repeater. Make sure the AC cable is correctly connected.
 - When using only DC power, turn the [POWER] switch ON then push the [DC RESET] switch to apply power. Confirm that the [POWER] indicator lights up in red.
- 2) Set repeater mode for either a private or open repeater.

For private repeaters:

Push the [CTCSS] switch ON. The [CTCSS] indicator lights up and the repeater transmits only received signals with specified subaudible tones superimposed on them.

For open repeaters:

Push the [CTCSS] switch to turn OFF the tone squelch function if the [CTCSS] indicator lights up. The repeater transmits all receive signals if the [CTCSS] indicator does not light up.

- 3) That the [SQUELCH] control is rotated maximum clockwise.
- 4) That the supplied HM-4 microphone is connected to the mic connector.
- 5) Rotate the [SQUELCH] control clockwise until the [BUSY] indicator goes OFF and noise from the speaker disappears.
 - The level of this control determines the level of the input signals to be repeated. Adjust [SQUELCH] as required to repeat only strong signals.
- 6) Rotate the [VOLUME] control maximum counterclockwise as the monitor signal from the speaker is not related to repeater functioning.

● MICROPHONE FUNCTION

Push and hold the [PTT] switch on the microphone to transmit your voice.

The repeater functions as a transceiver when [LOCAL INHIBIT] is ON and the PTT switch is pushed. Speak into the microphone using your normal voice level. Be sure not to overlap voice signals on the modulation of received signals. See p. 5 for additional information.

● COR SIMULATE FUNCTION

The repeater can be set in continuous transmit mode for checking repeater operation when [COR SIMULATE] is pushed IN. Check the following functions.

1. Time-out timer
2. Hang-up timer
3. Repeat stopping time
4. ID speed
5. ID function

4 BASIC PRESETTINGS

WARNING: DISCONNECT the AC power cable from the repeater before performing any work on the repeater.

4-1 SETTING A FREQUENCY

The transmit and receive frequencies can be set by dip switches on the LOGIC-A UNIT. See p. 18 for the LOGIC-A UNIT location. See p. 19 for each switch location.

- 1) Remove the bottom cover.
 - Remove 6 screws on the bottom cover and another 3 screws on each side of the front panel.
- 2) Setting the PLL reference frequency
 - Turn ON S4-1 on the LOGIC-A UNIT to set the PLL reference frequency for 5 kHz.
 - Turn OFF S4-1 on the LOGIC-A UNIT to set the PLL reference frequency for 12.5 kHz.

3) Setting the PLL N-data

$$\text{N-data for receiving} = \frac{\text{receive frequency} - 1\text{st IF frequency (MHz)}}{\text{PLL reference frequency (MHz)}}$$

$$\text{N-data for transmitting} = \frac{\text{transmit frequency (MHz)}}{\text{PLL reference frequency (MHz)}}$$

Set the N-data obtained in the above formula by using the dip switches. Every dip switch has an independent volume of N-data.

NOTE: Confirm that the dip switches are correctly set, and apply power to confirm the operating frequency after replacing the bottom cover.

● Example of setting N-data for receiving

Receive frequency : 444.750 MHz
 1st IF frequency : 30.875 MHz (fixed)
 PLL reference frequency : 0.005 MHz (5 kHz)

$$\begin{aligned} \text{N-data for receiving} &= \frac{\text{receive frequency} - 1\text{st IF frequency}}{\text{PLL reference frequency}} \\ &= \frac{444.75 - 30.875}{0.005} \\ &= 82775 \end{aligned}$$

Set dip switches (S1, S2) at the values equivalent to the obtained N-data.

Example of setting dip switches

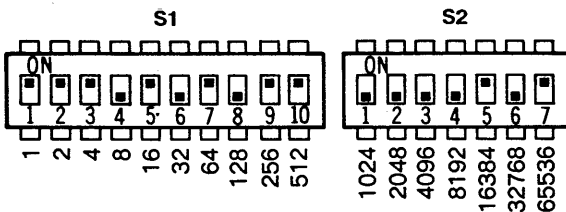

Dip switches	N-data value
S2-7 →	65536
S2-5 →	16384
S1-10 →	512
S1-9 →	256
S1-7 →	64
S1-5 →	16
S1-3 →	4
S1-2 →	2
S1-1 →	1 (+)
Total	82775

● Example of setting N-data for transmitting

Transmit frequency : 439.750 MHz
 PLL reference frequency : 0.0125 MHz (12.5 kHz)

$$\begin{aligned} \text{N-data for transmitting} &= \frac{\text{transmit frequency}}{\text{PLL reference frequency}} \\ &= \frac{439.75}{0.0125} \\ &= 35180 \end{aligned}$$

Set dip switches (S9, S10) at the values equivalent to the obtained N-data.

Example of setting dip switches

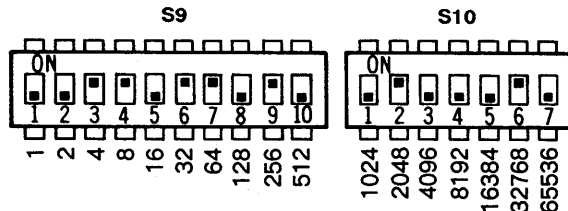

Dip switches	N-data value
S10-6 →	32768
S10-2 →	2048
S9-9 →	256
S9-7 →	64
S9-6 →	32
S9-4 →	8
S9-3 →	4 (+)
Total	35180

4-2 SETTING A TONE FREQUENCY

(1) SUBAUDIBLE TONE DECODER FREQUENCY

The subaudible tone decoder frequency for the tone squelch function can be set by dip switches on the LOGIC-A UNIT. Be sure to disconnect the AC power cable when setting the frequency.

1) Remove the bottom cover.

- Remove 6 screws on the bottom cover and another 3 screws on each side of the front panel of the repeater.

2) Set the dip switches on S3 as desired according to the following chart.

- The tone numbers are used for setting the subaudible tone decoder frequency with DTMF signals.

Example of setting dip switches (88.5 Hz)

S3

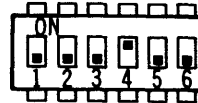

TONE NUMBER	SUBAUDIBLE TONE DECODER FREQUENCY (Hz)	S3						TONE NUMBER	SUBAUDIBLE TONE DECODER FREQUENCY (Hz)	S3					
		1	2	3	4	5	6			1	2	3	4	5	6
01	67.0	ON	-	-	-	-	-	20	131.8	-	-	ON	-	ON	-
02	71.9	-	ON	-	-	-	-	21	136.5	ON	-	ON	-	ON	-
03	74.4	ON	ON	-	-	-	-	22	141.3	-	ON	ON	-	ON	-
04	77.0	-	-	ON	-	-	-	23	146.2	ON	ON	ON	-	ON	-
05	79.7	ON	-	ON	-	-	-	24	151.4	-	-	-	ON	ON	-
06	82.5	-	ON	ON	-	-	-	25	156.7	ON	-	-	ON	ON	-
07	85.4	ON	ON	ON	-	-	-	26	162.2	-	ON	-	ON	ON	-
08	88.5	-	-	-	ON	-	-	27	167.9	ON	ON	-	ON	ON	-
09	91.5	ON	-	-	ON	-	-	28	173.8	-	-	ON	ON	ON	-
10	94.8	-	ON	-	ON	-	-	29	179.9	ON	-	ON	ON	ON	-
11	97.4				Not assigned			30	186.2	-	ON	ON	ON	ON	-
12	100.0	-	-	ON	ON	-	-	31	192.8	ON	ON	ON	ON	ON	-
13	103.5	ON	-	ON	ON	-	-	32	203.5	-	-	-	-	-	ON
14	107.2	-	ON	ON	ON	-	-	33	210.7	ON	-	-	-	-	ON
15	110.9	ON	ON	ON	ON	-	-	34	218.1	-	ON	-	-	-	ON
16	114.8	-	-	-	-	ON	-	35	225.7	ON	ON	-	-	-	ON
17	118.8	ON	-	-	-	ON	-	36	233.6	-	-	ON	-	-	ON
18	123.0	-	ON	-	-	ON	-	37	241.8	ON	-	ON	-	-	ON
19	127.3	ON	ON	-	-	ON	-	38	250.3	-	ON	ON	-	-	ON

-: OFF

4 BASIC PRESETTINGS

(2) SUBAUDIBLE TONE ENCODER FREQUENCY

The subaudible tone encoder frequency can be set by dip switches on the LOGIC-A UNIT. Be sure to disconnect the AC power cable when setting the frequency.

1) Remove the bottom cover.

- Remove 6 screws on the bottom cover and another 3 screws on each side of the front panel of the repeater.

2) Set dip switches on S11 as desired according to the following table.

- The tone numbers are used for setting the subaudible tone encoder frequency with DTMF signals.

Example of setting dip switches (88.5 Hz)

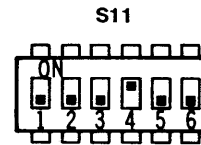

TONE NUMBER	SUBAUDIBLE TONE ENCODER FREQUENCY (Hz)	S11						TONE NUMBER	SUBAUDIBLE TONE ENCODER FREQUENCY (Hz)	S11					
		1	2	3	4	5	6			1	2	3	4	5	6
01	67.0	ON	-	-	-	-	-	20	131.8	-	-	ON	-	ON	-
02	71.9	-	ON	-	-	-	-	21	136.5	ON	-	ON	-	ON	-
03	74.4	ON	ON	-	-	-	-	22	141.3	-	ON	ON	-	ON	-
04	77.0	-	-	ON	-	-	-	23	146.2	ON	ON	ON	-	ON	-
05	79.7	ON	-	ON	-	-	-	24	151.4	-	-	-	ON	ON	-
06	82.5	-	ON	ON	-	-	-	25	156.7	ON	-	-	ON	ON	-
07	85.4	ON	ON	ON	-	-	-	26	162.2	-	ON	-	ON	ON	-
08	88.5	-	-	-	ON	-	-	27	167.9	ON	ON	-	ON	ON	-
09	91.5	ON	-	-	ON	-	-	28	173.8	-	-	ON	ON	ON	-
10	94.8	-	ON	-	ON	-	-	29	179.9	ON	-	ON	ON	ON	-
11	97.4	ON	ON	-	ON	-	-	30	186.2	-	ON	ON	ON	ON	-
12	100.0	-	-	ON	ON	-	-	31	192.8	ON	ON	ON	ON	ON	-
13	103.5	ON	-	ON	ON	-	-	32	203.5	-	-	-	-	-	ON
14	107.2	-	ON	ON	ON	-	-	33	210.7	ON	-	-	-	-	ON
15	110.9	ON	ON	ON	ON	-	-	34	218.1	-	ON	-	-	-	ON
16	114.8	-	-	-	-	ON	-	35	225.7	ON	ON	-	-	-	ON
17	118.8	ON	-	-	-	ON	-	36	233.6	-	-	ON	-	-	ON
18	123.0	-	ON	-	-	ON	-	37	241.8	ON	-	ON	-	-	ON
19	127.3	ON	ON	-	-	ON	-	38	250.3	-	ON	ON	-	-	ON

--: OFF

5-1 ID FUNCTION

(1) AUTOMATIC ID FUNCTION

This is a function that automatically transmits the call sign of the repeater. The waveform is CW (F2) and one of the three different transmit patterns can be selected using S12 on the LOGIC-A UNIT. See pgs. 11~13 for the ID transmit patterns.

ID TRANSMIT PATTERN	TYPE A	TYPE B	TYPE C	NOT USED	
S12	1	OFF	ON	ON	OFF
	2	ON	OFF	ON	OFF

S17	0	1	2	3	4	5	6	7	8	9	A	B	C	D	E	F
ID SPEED (wpm)	4	5	6	7	8	10	12	14	16	18	20	22	24	26	28	30

NOTE: The ID function of the IC-RP4020 is turned OFF in some versions. Turn ON S4-2 on the LOGIC-A UNIT to activate the ID function.

(2) MANUAL ID FUNCTION

The ID call sign can be transmitted manually when the [MANUAL ID] switch is pushed.

The ID speed can be selected within a range of 4~30 wpm using S17 on the LOGIC-A UNIT. See the table below.

5-2 HANG-UP TIMER FUNCTION

The repeater continues transmitting for approx. 1 second after a receive signal disappears. This time is preset at the factory. When the repeater is accessed at this time, the transmit operation resumes immediately.

The repeater is thus prevented from turning OFF during short pauses when stations are using the repeater. The time period can be set between 0 and 15 second using S18 on the LOGIC-A UNIT.

S18	0	1	2	3	4	5	6	7	8	9	A	B	C	D	E	F
HANG-UP TIME (sec.)	0	1	2	3	4	5	6	7	8	9	10	11	12	13	14	15

5-3 TIME-OUT TIMER FUNCTION

This function is designed to inhibit one station from using the repeater excessively. If a station continues to access the repeater beyond the set time (set at 3 minutes at the factory), the repeater automatically stops repeat operations for 5 seconds (preset).

The time-out time can be set within a range of 1~15 minutes, or in an unlimited range using S19 on the LOGIC-A UNIT. The repeat stopping time after the time-out time can be set within a range of 0~10 minutes using S20 on the LOGIC-A UNIT.

NOTE: J6 of pin 6 on the LOGIC UNIT outputs a pulse at 30 seconds before the time-out time. This pulse can be used for time-out time notice, etc.

If the station continues accessing 5 seconds later, the repeater resumes the repeat operation and transmits an ID call sign.

S19	0	1	2	3	4	5	6	7	8	9	A	B	C	D	E	F
TIME-OUT TIME (sec.)	1	2	3	4	5	6	7	8	9	10	11	12	13	14	15	unlimited

S20	0	1	2	3	4	5	6	7	8	9	A	B	C	D	E	F
REPEAT STOPPING TIME (sec.)	0	1	2	3	5	10	15	20	30	40	50	60	120	180	300	600

5 FUNCTIONS PRESETTINGS AND OPERATION

5-4 ID TIMING CHART

The repeater has three different ID transmit patterns. The patterns are type A, type B and type C. The following charts show ID transmit timing and difference of each transmit pattern. Each chart shows a sample of repeater operation. The charts also show how the repeater operates.

- Types of timers (factory default)
 - a. Hang-up time (1 second)
 - b. Time-out time (3 minutes)
 - c. Repeat stopping time after time-out time (5 seconds)

• Type A

① In case 1 station monopolizes the repeater for 3 minutes or more.

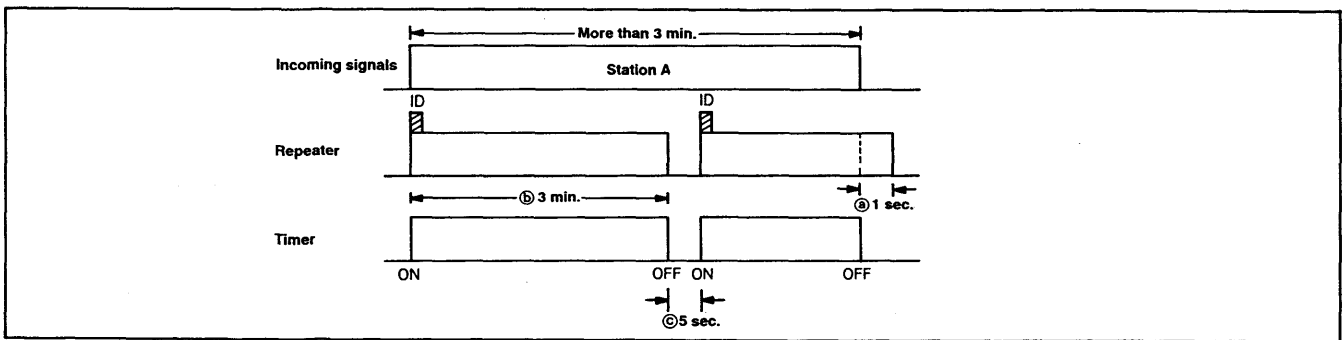

② In case 2 stations communicate for 3 minutes or more without intervals of 1 second or more.

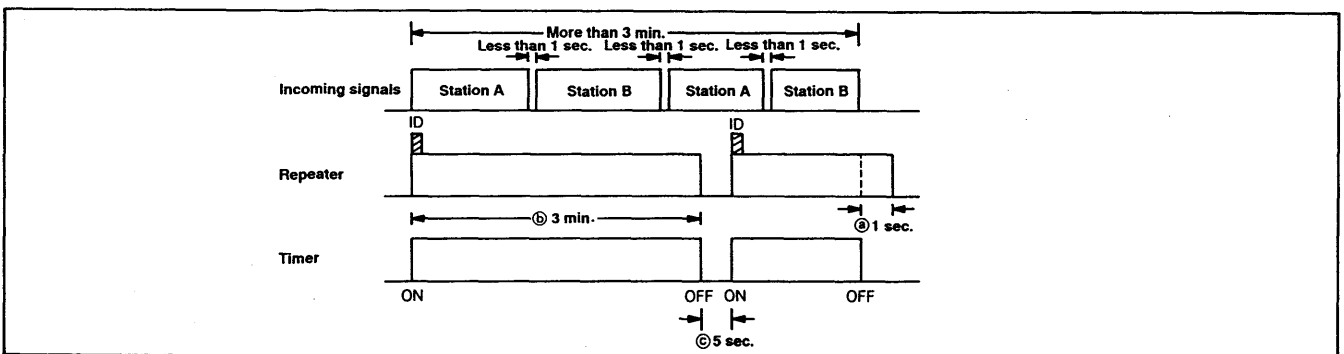

③ In case 2 stations communicate at intervals of 1 second or more.

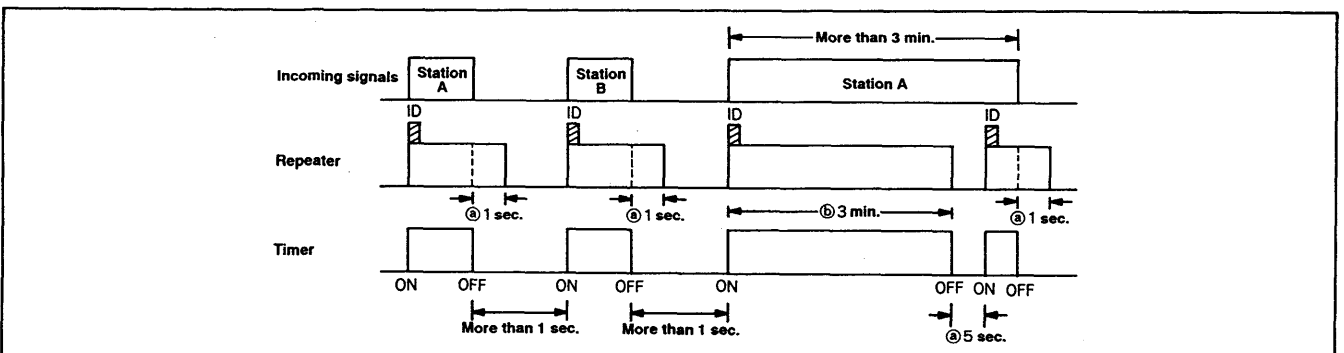

● Type B

- ① In case 2 stations communicate without intervals of 1 second or more.

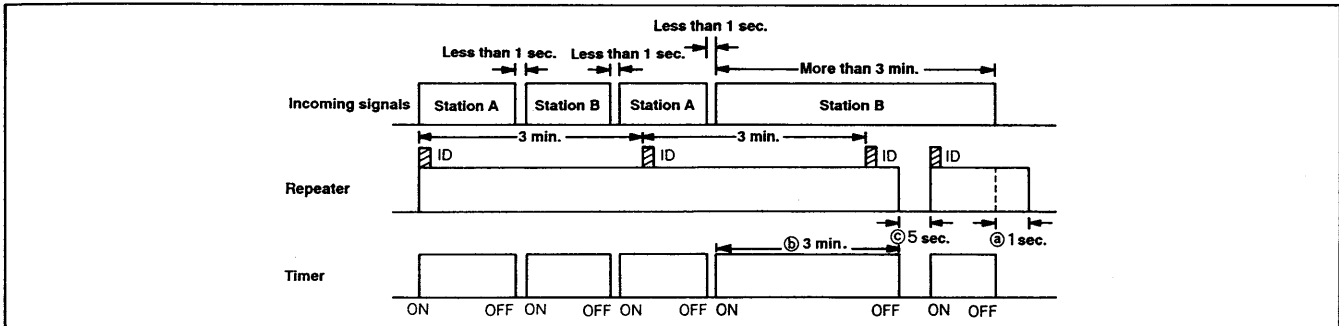

- ② In case 1 station monopolizes the repeater for 3 minutes or more.
 ● The repeater functions the same as Type A item 1 above.

- ③ In case 2 stations communicate at intervals of 1 second or more.
 ● The repeater functions the same as type A item 3 above.

● Type C

- ① In case 1 station monopolizes the repeater for 3 minutes or more.

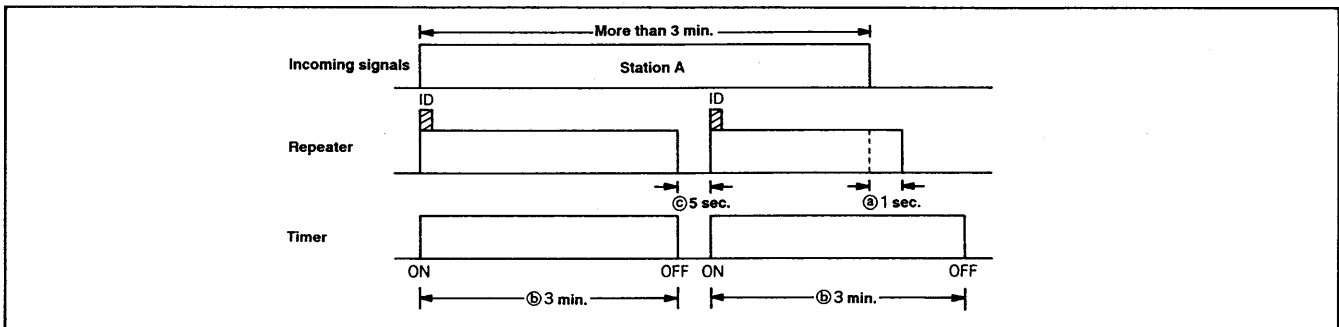

- ② In case 2 stations communicate for 3 minutes or more without intervals of 1 second or more.

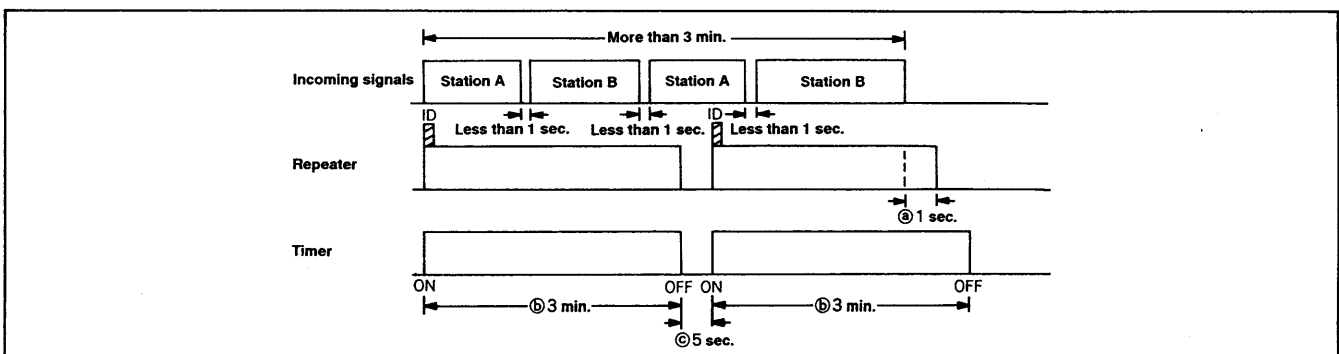

5 FUNCTIONS PRESETTINGS AND OPERATION

- ③ In case communication between 2 stations is completed within 3 minutes, and then other stations use the repeater at intervals of 1 second or more.

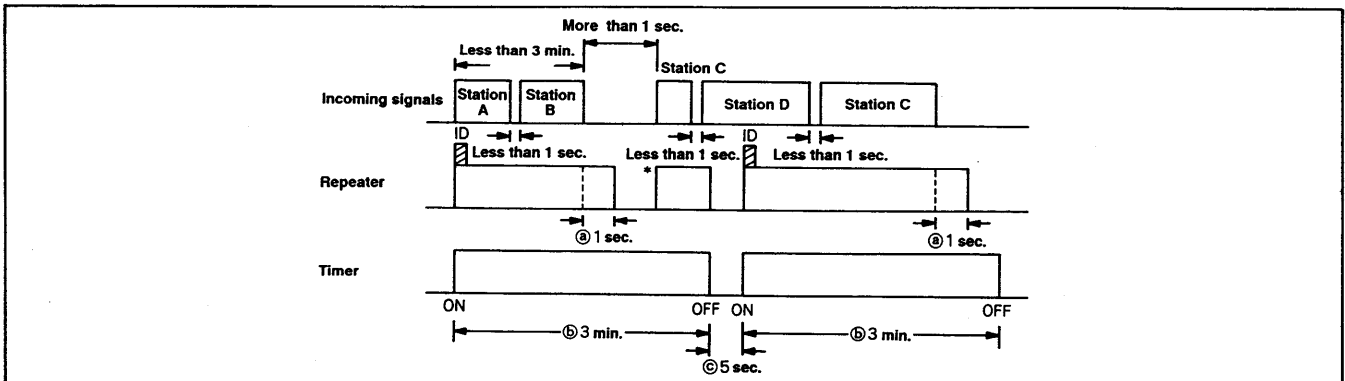

* No ID is transmitted.

5-5 WRITING THE ID CALL SIGN

Up to 20 characters including spaces can be stored as the ID call sign. Write the ID call sign as follows:

- 1) Remove the bottom cover.
 - Remove 6 screws on the bottom cover and another 3 screws on each side of the front panel.
 - 2) Clear the previous ID call sign.
 - Set both S7 and S8 on the LOGIC-A UNIT to "C" and then push S6 on the LOGIC-A UNIT.
 - 3) To write the first ID character, set S7 and S8 to select a desired character, then push S6. The table at right shows the relation between a character and the position of S7 and S8.
- NOTE:** The vacant combination of S7 and S8 will be invalid when S6 is pushed.
- 4) To write the second ID character, set S7 and S8 to select the desired character.
 - 5) Repeat item 3) until the ID call sign is completely written.
 - 6) If the ID call sign consists of 19 characters or less, set S7 and S8 to "F" and then push S6 to skip the unnecessary spaces.

		S7 (LOGIC-A UNIT)															
		0	1	2	3	4	5	6	7	8	9	A	B	C	D	E	F
S8 (LOGIC-A UNIT)	0	0	1	2	3	4	5	6	7	8	9						
	1	A	B	C													
	2	D	E	F													
	3	G	H	I													
	4	J	K	L													
	5	M	N	O													
	6	P	Q	R													
	7	S	T	U													
	8	V	W	X													
	9	Y	Z	/													
	A												space				
B												erase					
C																	
D																	
E																	
F												skip					

5-6 EXTERNAL CONTROL FUNCTION

This function remotely controls the repeater using DTMF signals. To control the repeater, input DTMF signals to the [CONTROL INPUT] jack on the rear panel or transmit the DTMF signals on the frequency received by the repeater.

- Using the [CONTROL INPUT] jack
To control the repeater, send DTMF signals for reception by a receiver installed at the repeater location. A control signal transmitter is necessary.
- Using the repeater receive frequency
Transmit DTMF signals by a 430 MHz band transmitter to remotely control the repeater. A 430 MHz band control signal transmitter is necessary.

One frame of a control signal used with DTMF signals consists of five fields as shown at right. 4-digit password in the frame can be set by S13~S16 on the LOGIC-A UNIT. Use the following commands and data in the table to transmit a frame as a control signal.

Composition of the DTMF control signals

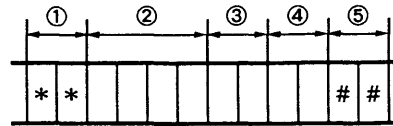

- ① preamble
- ② password*1
- ③ command
- ④ data*2
- ⑤ postamble (conclusion)

*1 Set each switch at 0~9 or A~D. If the first digit of the password (S13) is 0~9, stop the repeater transmission so that the following control signals may not flow to the downlink side. Transmission resumes when the postamble (#, #) is received.

*2 Data length depends on the command.

NOTE: Input the DTMF control signals within 30 seconds. Unless the input is completed within the time limit, the control signals will be invalid.

COMMAND		DATA	DESCRIPTION	INITIAL CONDITION	
SUBCOMMAND-1	SUBCOMMAND-2				
0	0	0	Turns [CTCSS] OFF.	ON	
		1	Turns [CTCSS] ON.		
	1	0	Turns the subaudible tone encoder OFF.	OFF	
		1	Turns the subaudible tone encoder ON.		
2	0	01 ~ 10, 12 ~ 38	Selects the subaudible tone decoder frequency number.	See below. *1	
	3	01 ~ 38	Selects the subaudible tone decoder frequency number.		
1	0	0	Turns [LOCAL INHIBIT] OFF.	OFF	
		1	Turns [LOCAL INHIBIT] ON.		
2	0	1	Transmits the ID call sign once.	ON *2	
	1	0	Turns the ID function OFF.		
		1	Turns the ID function ON.		
3	0	0	Turns the control output (1) OFF.	LOGIC UNIT J6 pin 4	OFF
		1	Turns the control output (1) ON.		
	1	0	Turns the control output (2) OFF.	LOGIC UNIT J6 pin 3	OFF
		1	Turns the control output (2) ON.		
	2	0	Turns the control output (0) OFF.	LOGIC UNIT J6 pin 5	OFF
		1	Turns the control output (0) ON.		
4	0	01 ~ 16	Selects the time-out time.	See below. *1	
	1	01 ~ 16	Selects the hang-up time.		
	2	01 ~ 16	Selects the repeat stopping time.		
	3	01 ~ 16	Selects the ID speed.		
A	0	01 ~ 07	Adjusts the operating frequency. (-1 ~ -7 position)	±0	
		11 ~ 17	Adjusts the operating frequency. (+1 ~ +7 position)		
D	9	9	Resets the CPU.		

*1 The initial conditions are determined by the dip switches on the LOGIC-A UNIT.

*2 The ID function can be remotely controlled when S4-2 on the LOGIC-A UNIT is turned ON.

*3 CPU resetting by the DTMF signals cannot reset the PLL reference frequency adjustment and ID function ON/OFF.

6-1 REPEATER DISASSEMBLY

WARNING: DISCONNECT the AC power cable from the repeater before performing any work on the repeater.

- 1) Turn the [POWER] switch OFF.
- 2) Disconnect the AC power cable.
- 3) Unscrew 6 screws from rack mounting handles and remove the rack mounting handles.
- 4) Unscrew 3 screws from each side of the front panel.
- 5) Unscrew 12 screws on top and bottom covers.
- 6) Remove top and bottom covers.

6-2 FUSE REPLACEMENT

If the fuse blows or the repeater stops functioning, find the source of the problem if possible, and replace the damaged fuse with a new, rated fuse.

- 2 fuses are installed in the repeater:
- Rear panel AC line fuse holder:
3 A for 10 W and 25 W versions
5 A for 50 W version
 - Rear panel DC line fuse holder:
10 A for 10 W and 25 W versions
20 A for 50 W version

6-3 BACKUP BATTERY

The repeater has a lithium backup battery installed. The usual life of the battery is approximately 5 years. If the battery is exhausted, transmitting and receiving normally but ID information in the RAM IC chip is not retained each time the power is turned ON.

NOTE: Backup battery replacement should be done by an authorized Icom Dealer or Service Center.

6-4 CLEANING

If the repeater becomes dusty or dirty, wipe it clean with a dry, soft cloth. Avoid the use of strong cleaning agents such as benzene or alcohol as they may damage the surfaces of the repeater.

6-5 CPU RESETTING

The repeater may occasionally operate erroneously, e.g., when first applying power. This may be caused externally by static electricity or other factors.

If this problem occurs, turn the [POWER] switch OFF. Wait a few minutes, and then turn ON power again. The CPU has been reset.

CPU resetting can be remotely controlled by a control operator using DTMF signals. The DTMF signals must be sent as follows:

- 1) Transmit "*" signals twice as the preamble.
- 2) Transmit your 4-digit password.
- 3) Transmit "D" signals once and "9" signals twice as the command and data for CPU resetting.
- 4) Transmit "#" signals twice as the postamble.

The CPU has been reset. The PLL reference frequency adjustment and ID function are not reset.

CAUTION: CPU resetting clears all information. The repeater is set to initial conditions.

Composition of the DTMF control signals for CPU resetting

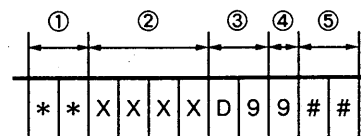

- | | |
|------------|-------------|
| ① preamble | ④ data |
| ② password | ⑤ postamble |
| ③ command | |

6-6 TROUBLESHOOTING

The following chart is designed to help you correct problems which are not equipment malfunctions.

If you are unable to locate the cause of the problem or solve it through use of this chart, contact your nearest Icom Dealer or Service Center.

PROBLEM	POSSIBLE CAUSE	SOLUTION	REF.
1. Power does not come on when [POWER] is pushed.	<ul style="list-style-type: none"> ● Power cable is improperly connected. ● Power cable is cut. ● Fuse is blown. ● Polarity of the power connection is reversed when the DC power source is used. ● [DC RESET] have not pushed for DC operation. ● The battery for DC operation is discharged. 	<ul style="list-style-type: none"> ● Connect the power cable securely. ● Check the cable continuity. ● Check for the cause, then replace the fuse with a spare one. ● Reconnect the power cable observing the proper polarity, then replace the DC fuse with a spare one. ● Push [DC RESET] to start the power. ● Charge the battery. 	<p>p. 5</p> <p>p. 15</p> <p>pgs. 5, 15</p> <p>p. 6</p> <p>p. 5</p>
2. No sound comes from the speaker or volume is too low.	<ul style="list-style-type: none"> ● Volume level is too low. ● The squelch is closed. ● W8 on the LED UNIT is cut. ● Wrong N-data or PLL reference frequency is set. 	<ul style="list-style-type: none"> ● Rotate [VOLUME] CW to obtain a suitable listening level. ● Rotate [SQUELCH] CCW to open the squelch. NOTE: If [CTCSS] is turned OFF, the repeater transmits when the squelch is open. ● Solder W8. ● Reset the N-data or PLL reference frequency. 	<p>p. 6</p> <p>p. 6</p> <p>p. 5</p> <p>p. 7</p>
3. Sensitivity is low.	<ul style="list-style-type: none"> ● The antenna feedline is cut or shorted. ● N-data setting is outside the duplexer bandwidth. 	<ul style="list-style-type: none"> ● Check the feedline and correct any improper conditions. ● Reset the N-data. 	<p>p. 4</p> <p>p. 7</p>
4. Received signal is not retransmitted.	<ul style="list-style-type: none"> ● [LOCAL INHIBIT] is pushed IN. ● Wrong subaudible tone decoder frequency is set. ● [SQUELCH] is rotated too far CW. 	<ul style="list-style-type: none"> ● Push [LOCAL INHIBIT] OUT. ● Reset the subaudible tone decoder frequency. ● Rotate [SQUELCH] CCW to set the required repeat signal level. 	<p>p. 1</p> <p>p. 8</p> <p>p. 6</p>
5. No output power or the output is too low.	<ul style="list-style-type: none"> ● Mic connector has a poor contact. ● Wrong N-data or PLL reference frequency is set. ● N-data setting is outside the duplexer bandwidth. ● The antenna feedline is cut or shorted. 	<ul style="list-style-type: none"> ● Check the connector pins. ● Reset the N-data or PLL reference frequency. ● Reset the N-data. ● Check the feedline and correct any improper conditions. 	<p>p. 5</p> <p>p. 7</p> <p>p. 7</p> <p>p. 4</p>
6. ID call sign is not sent out.	<ul style="list-style-type: none"> ● ID function is turned OFF. ● Backup battery is exhausted. 	<ul style="list-style-type: none"> ● Turn ID function switch ON. ● Replace the backup battery and input the ID call sign. CAUTION: Battery replacement should be done by an authorized Icom Dealer or Service Center. 	<p>p. 10</p> <p>p. 15</p>
7. Transmit signal is not modulated.	<ul style="list-style-type: none"> ● Mic connector has a poor contact. 	<ul style="list-style-type: none"> ● Check the connector pins. 	<p>p. 5</p>

CW: Clockwise CCW: Counterclockwise

7-1 TOP VIEW

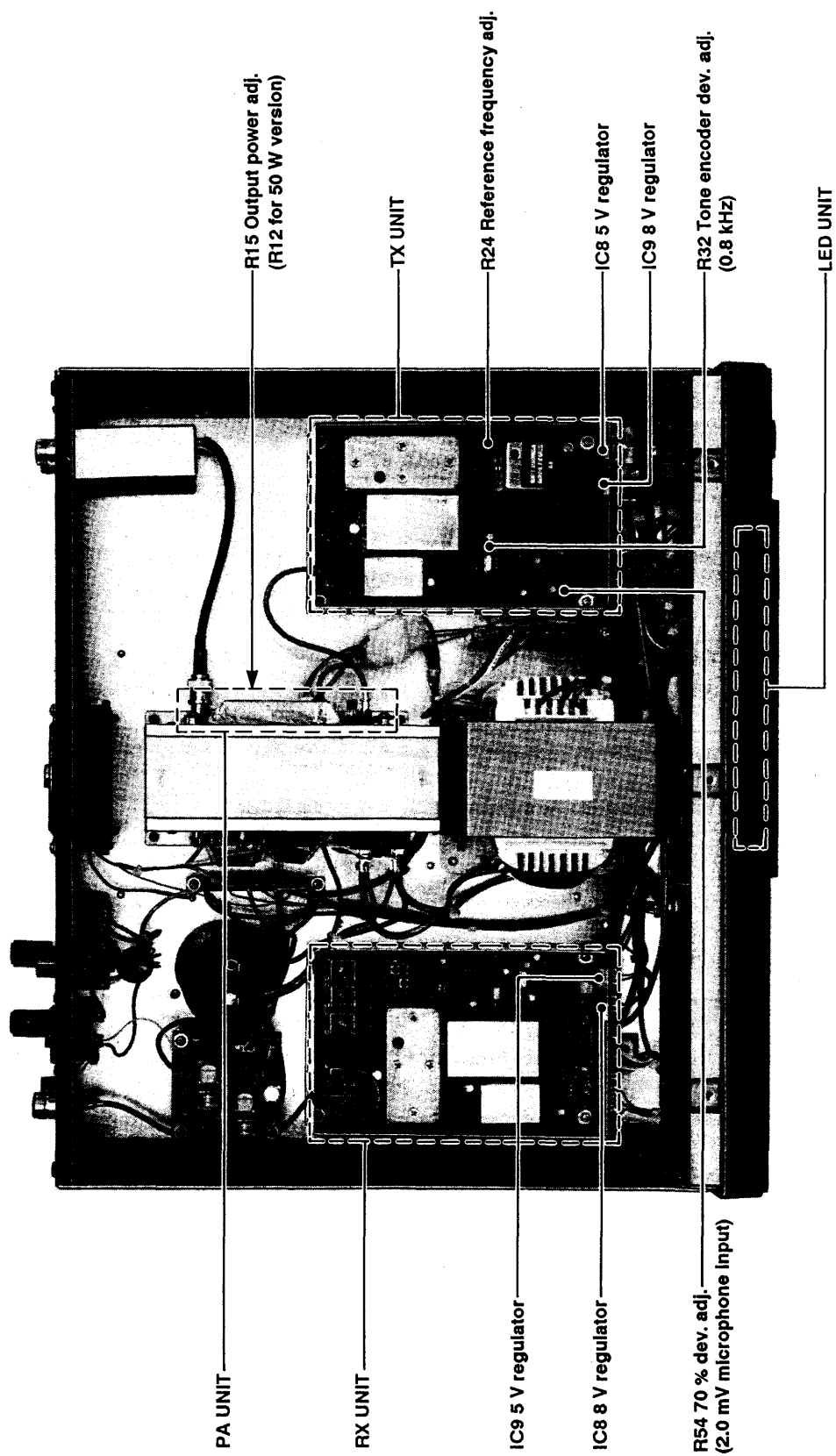

7-2 BOTTOM VIEW

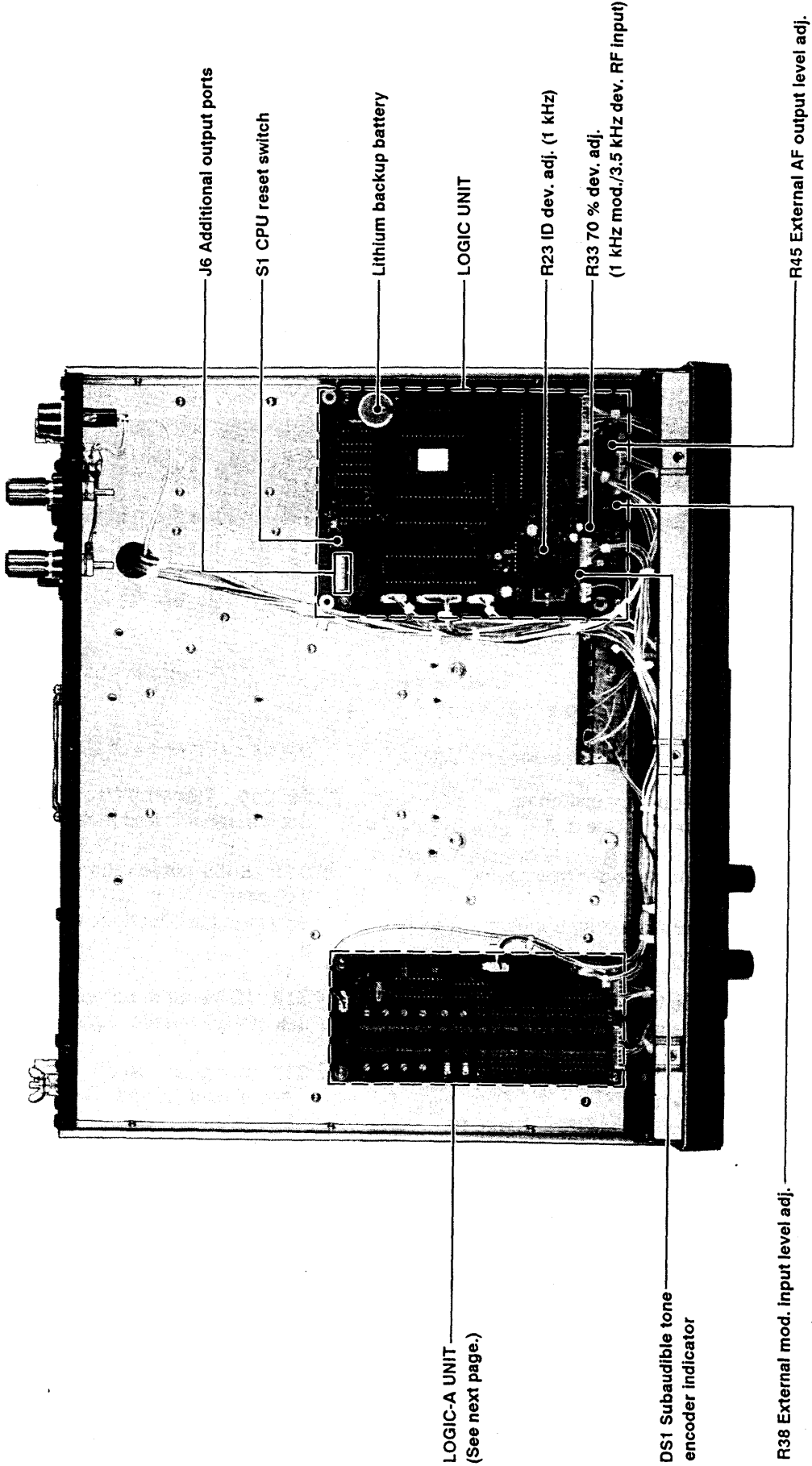

7-3 LOGIC-A UNIT

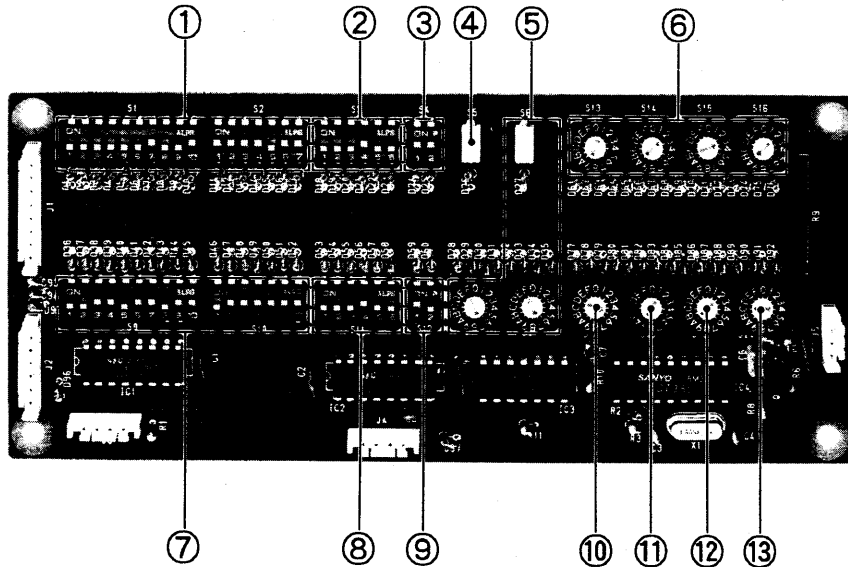

- ① **S1, S2 Receive frequency switches**
Set the receive frequency. See p. 7.
- ② **S3 Subaudible tone decoder frequency switches**
Set the subaudible tone decoder frequency. See p. 8.
- ③ **S4-1 PLL reference frequency switch**
Selects the PLL reference frequency to 10 kHz or 25 kHz. See p. 7.
- S4-2 ID function switch**
Turns the ID function ON and OFF. See p. 10.
- ④ **S5 Subaudible tone encoder switch**
Turns the subaudible tone encoder ON and OFF.
The subaudible tone encoder indicator on the LOGIC UNIT lights up when the subaudible tone encoder is turned ON.
- ⑤ **S6~S8 ID writing switches**
Write the ID call sign. See p. 13.
- ⑥ **S13~S16 Password switches**
Set the password for external control function. See p. 14.
- ⑦ **S9, S10 Transmit frequency switches**
Set the transmit frequency. See p. 7.
- ⑧ **S11 Subaudible tone encoder frequency switches**
Set the subaudible tone encoder frequency. See p. 9.
- ⑨ **S12 ID transmit pattern switches**
Select the ID transmit pattern. See p. 10.
- ⑩ **S17 ID speed switch**
Selects the ID speed. See p. 10.
- ⑪ **S18 Hang-up timer switch**
Selects the hang-up time. See p. 10.
- ⑫ **S19 Time-out timer switch**
Selects the time-out time. See p. 10.
- ⑬ **S20 Repeater stopping time switch**
Selects the repeater stopping time. See p. 10.

GENERAL

- Frequency coverage :
430~450 MHz
- Mode :
F3 (FM)
- Initial tuning step :
5 kHz , 12.5 kHz
- Antenna impedance :
50 Ω
- Power supply requirement :
U.S.A. version 100~120 V AC
Europe version 220~240 V AC
All versions 13.8 V DC ±15 %
(negative ground)
- Current drain (at 13.8 V DC) :
Receive 1.0 A (standby)
1.2 A (max. audio output)
Transmit 7.0 A (10 W version)
10.0 A (25 W version)
17.0 A (50 W version)
- Usable temperature range :
-10 °C~ +60 °C (+ 14 °F~ + 140 °F)
- Frequency stability :
±1.0 ppm at -10 °C~ +60 °C (+ 14 °F~ + 140 °F)
- Dimensions :
425 (W) × 149 (H) × 368 (D) mm
16.7 (W) × 5.9 (H) × 14.5 (D) in
(projections not included)
- Weight :
17 kg (37.5 lb)

TRANSMITTER

- Output power :
10 W (10 W version)
25 W (25 W version)
50 W (50 W version)
- Modulation system :
Variable reactance frequency modulation
- Max. frequency deviation :
±5 kHz
- Spurious emissions :
Less than - 60 dB
- Microphone impedance :
600 Ω

RECEIVER

- Receiver system :
Double-conversion superheterodyne
- Intermediate frequency :
1st 30.875 MHz
2nd 455 kHz
- Sensitivity :
0.32 μV for 12 dB SINAD
- Squelch sensitivity :
Less than 0.25 μV
- Selectivity :
More than 15 kHz/- 6 dB
Less than 30 kHz/- 60 dB
- Spurious rejection :
More than 60 dB
- Audio output power :
More than 1.7 W at 10 % distortion with an 8 Ω load
- Audio output impedance :
8 Ω

All stated specifications are subject to change without notice or obligation.

Count on us!

